



## CENTRING PLATE SETS

For connecting two profiles at a 90° angle.

A threaded hole in a profile arranged at the end is required for mounting the item.

The screw must then be fixed through a further hole (accessible for an Allen key through the screw head) in the upright profile as shown here. See the table for suitable drilling measurements.

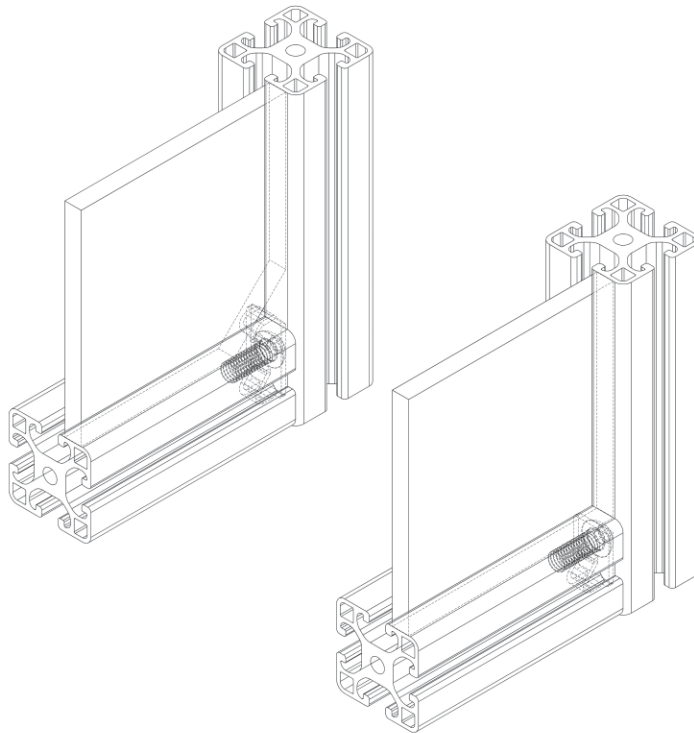
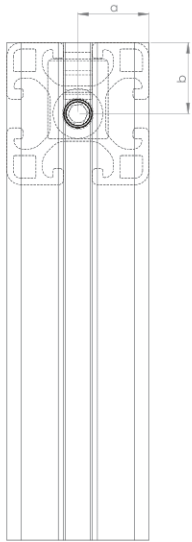



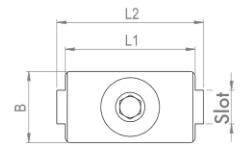
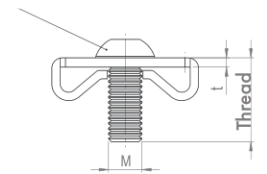



Screw, pan head, ISO 7380

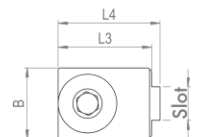
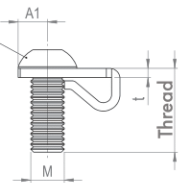

Screw, pan head, ISO 7380

Centring plate sets, unilateral



Description	Slot	Thread	a x b	D	L1 (mm)	L2 (mm)	L3 (mm)	L3 (mm)	t (mm)	A1 (mm)	Weight (g)	ESD	Art. no.:
Centring plate set 5	5	M5x12	10   10	Ø 4.3	16.4	19.9	-	-	1	-	4.0		380003
Centring plate set 6	6	M6x16	15   15	Ø 5.5	21	27.5	-	-	1.8	-	10.1		380005
Centring plate set 8	8	M8x20	20   20	Ø 7.0	31	35	-	-	2.2	-	19.9		380010
Centring plate set 8 VA	8	M8x20	20   20	Ø 7.0	31	35	-	-	2.2	-	18.7		380012
Centring plate set 8, unilateral	8	M8x20	20   20	Ø 7.0	-	-	22.3	24.3	2.2	7	17.6		380011