

SWIVELLING T-SLOT NUT SLOT 8 WITH SPRING SHEET

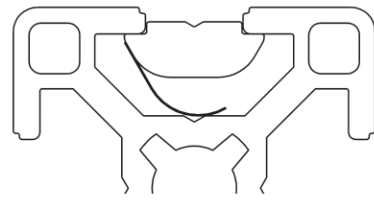

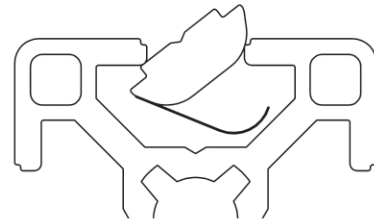
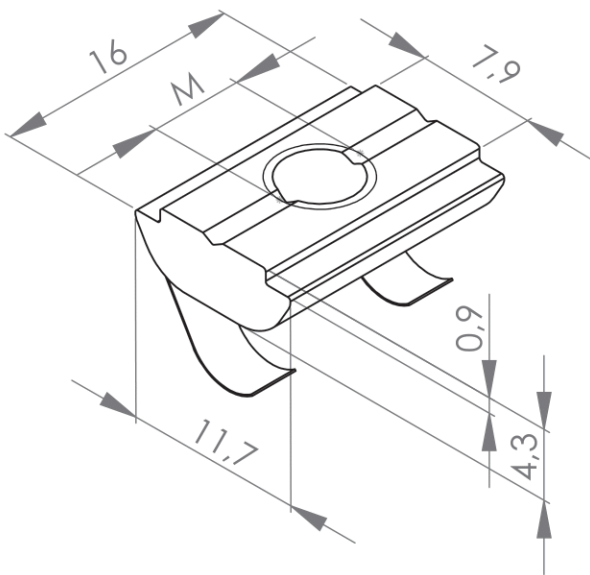

Material: steel, zinc-plated

Available with various thread sizes

The T-slot nuts can be swivelled into the profile slot inserted into the end. The bar of the T-slot nut centres the T-slot nut in the slot. The spring sheet fixes the T-slot nuts in place



Positioning the T-slot nut

Description	Slot	M (mm)	Material	Weight (g)	ESD	Art. no.:
Swivelling T-slot nut slot 8 with spring sheet	8	M4	Steel, zinc-plated	4.8		331005
	8	M5	Steel, zinc-plated	4.6		331020
	8	M6	Steel, zinc-plated	4.3		331040
	8	M8	Steel, zinc-plated	3.7		331060