

SWIVELLING T-SLOT NUT SLOT 10

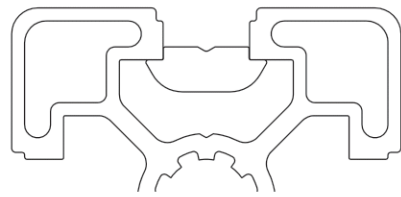

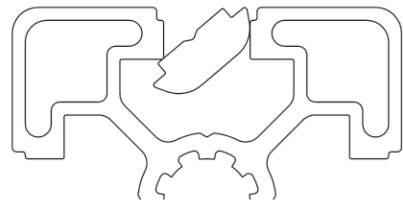
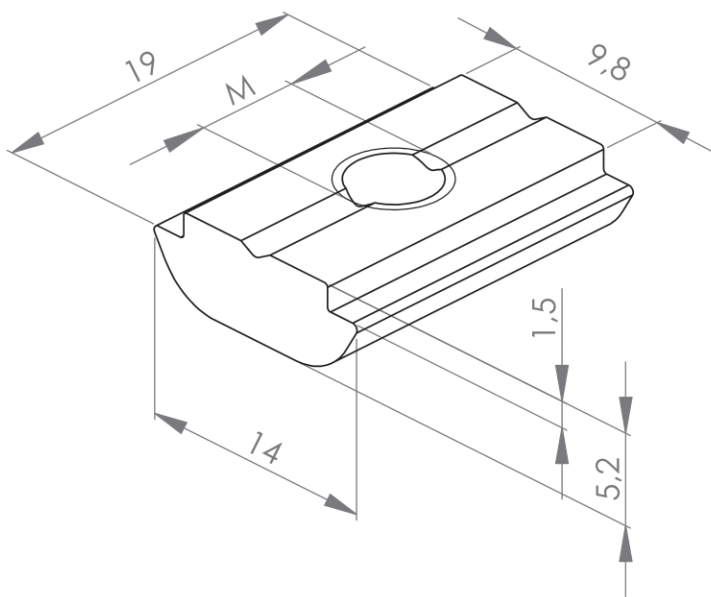

Material: steel, zinc-plated

Available with various thread sizes

The T-slot nuts can be swivelled into the profile slot inserted into the end. The bar of the T-slot nut centres the T-slot nut in the slot. A matching spring for fixing the T-slot nut in the slot can be found on [page 299](#)



Positioning the T-slot nut

| Description | Slot | M (mm) | Material | Weight (g) | ESD | Art. no.: |
|-------------------------------|------|--------|--------------------|------------|---|-----------|
| Swivelling T-slot nut slot 10 | 10 | M4 | Steel, zinc-plated | - |  | 332001 |
| | 10 | M5 | Steel, zinc-plated | - |  | 332010 |
| | 10 | M6 | Steel, zinc-plated | - |  | 332030 |
| | 10 | M8 | Steel, zinc-plated | - |  | 332050 |