

SWIVELLING T-SLOT NUT SLOT 10

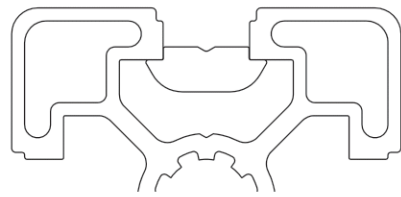

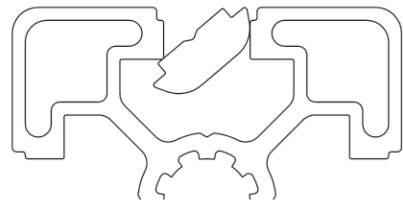
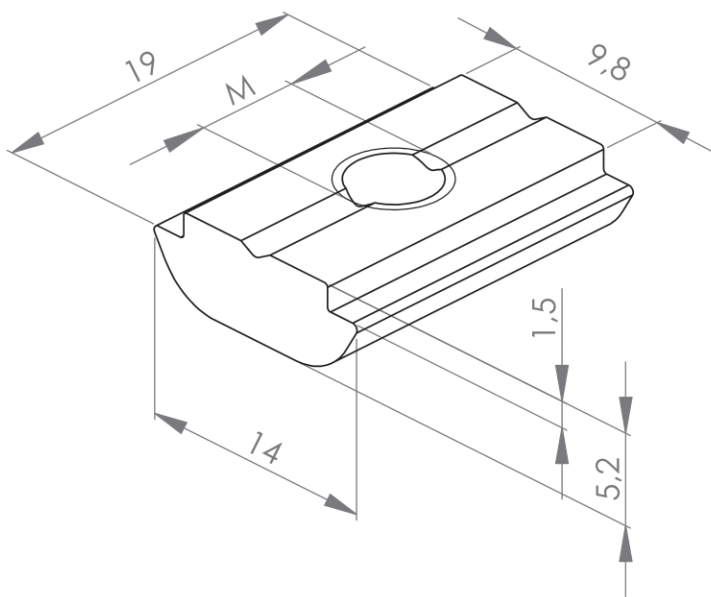

Material: steel, zinc-plated

Available with various thread sizes

The T-slot nuts can be swivelled into the profile slot inserted into the end. The bar of the T-slot nut centres the T-slot nut in the slot. A matching spring for fixing the T-slot nut in the slot can be found on [page 299](#)



Positioning the T-slot nut

Description	Slot	M (mm)	Material	Weight (g)	ESD	Art. no.:
Swivelling T-slot nut slot 10	10	M4	Steel, zinc-plated	-		332001
	10	M5	Steel, zinc-plated	-		332010
	10	M6	Steel, zinc-plated	-		332030
	10	M8	Steel, zinc-plated	-		332050