

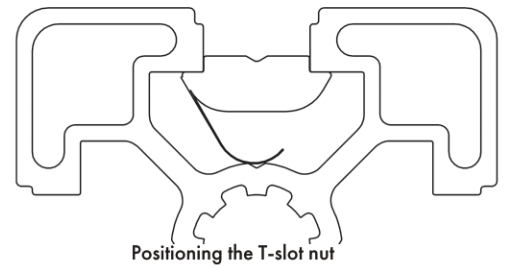

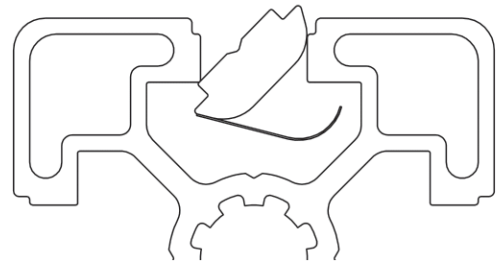
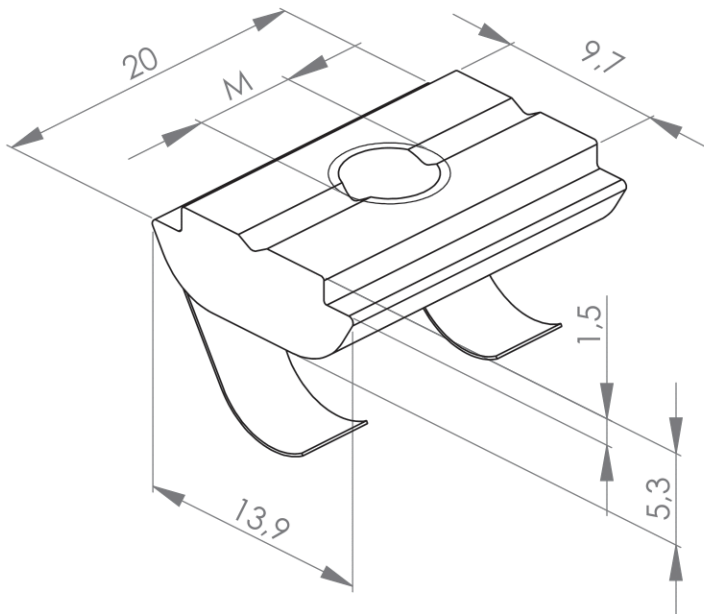

## SWIVELLING T-SLOT NUT SLOT 10 WITH SPRING SHEET

Material: steel, zinc-plated

Available with various thread sizes

The T-slot nuts can be swivelled into the profile slot inserted into the end. The bar of the T-slot nut centres the T-slot nut in the slot. The spring sheet fixes the T-slot nuts in place.



Description	Slot	M (mm)	Material	Weight (g)	ESD	Art. no.:
Swivelling T-slot nut slot 10 with spring sheet	10	M4	Steel, zinc-plated	9.1		332005
	10	M5	Steel, zinc-plated	8.7		332020
	10	M6	Steel, zinc-plated	8.6		332040
	10	M8	Steel, zinc-plated	7.8		332060