

## T-HEAD BOLTS AND FLANGED NUTS







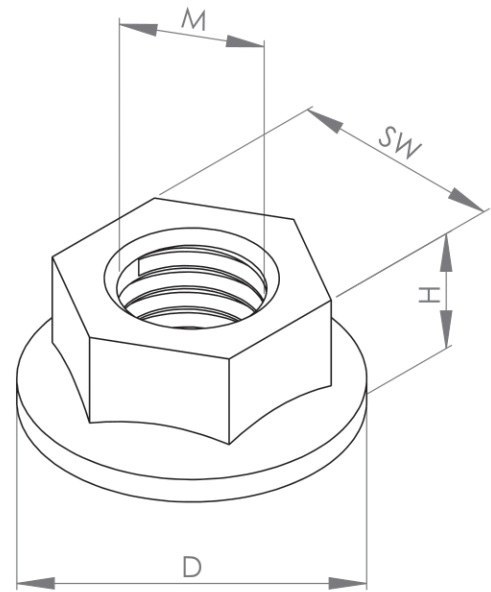
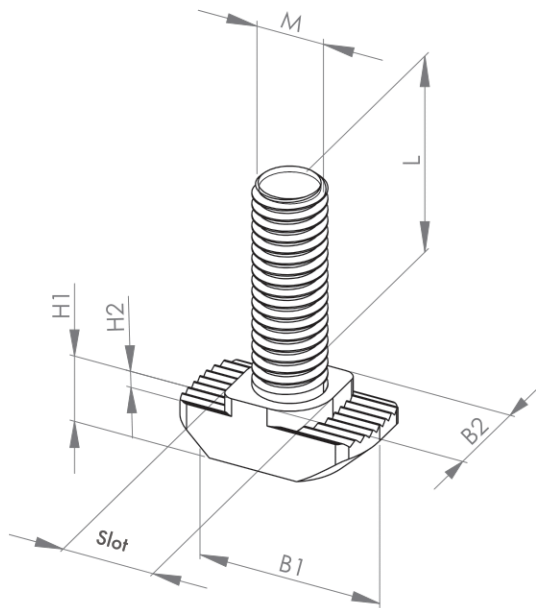

Material:

T-head bolts: steel, zinc-plated





Flanged nuts: steel, zinc-plated

For connecting a wide range of components to slot profiles.



Description	M	L (mm)	H1 (mm)	H2 (mm)	Slot (mm)	B1 (mm)	B2 (mm)	Weight (g)	ESD	Art. no.:
T-head bolt M6x16	M6	14.5	4.5	1.5	8	16	8	6.7		999317
T-head bolt M6x20	M6	18.5	4.5	1.5	8	16	8	7.1		999316
T-head bolt M6x25	M6	45	4.5	1.5	8	16	8	8.0		999310
T-head bolt M8x20	M8	17	5.7	3	10	19	8.5	12.4		999314
T-head bolt M8x25	M8	22	5.7	3	10	19	8.5	14.1		999315
T-head bolt M8x30	M8	27	5.7	3	10	19	8.5	15.3		999406
T-head bolt M8x40	M8	37	5.7	3	10	19	8.5	18.4		99900144
T-head bolt M8x50	M8	47	5.7	3	10	19	8.5	21.8		99900145

Description	M	D (mm)	SW (mm)	H (mm)	Weight (g)	ESD	Art. no.:
Flanged nut M6 Ø14	M6	14	10	6	3.4	-	999308
Flanged nut M8 Ø21	M8	21	13	8	10.2	-	999307

Description	M	Version	Weight (g)	ESD	Art. no.:
T-head bolts set M6x16	M6	With flanged nut	10.1		324015
T-head bolts set M8x20	M8	With flanged nut	22.6		324009
T-head bolts set M8x25	M8	With flanged nut	24.3		324010
T-head bolts set M8x30	M8	With flanged nut	25.5		324011