

JOINTS WITH AND WITHOUT CLAMPING LEVERS







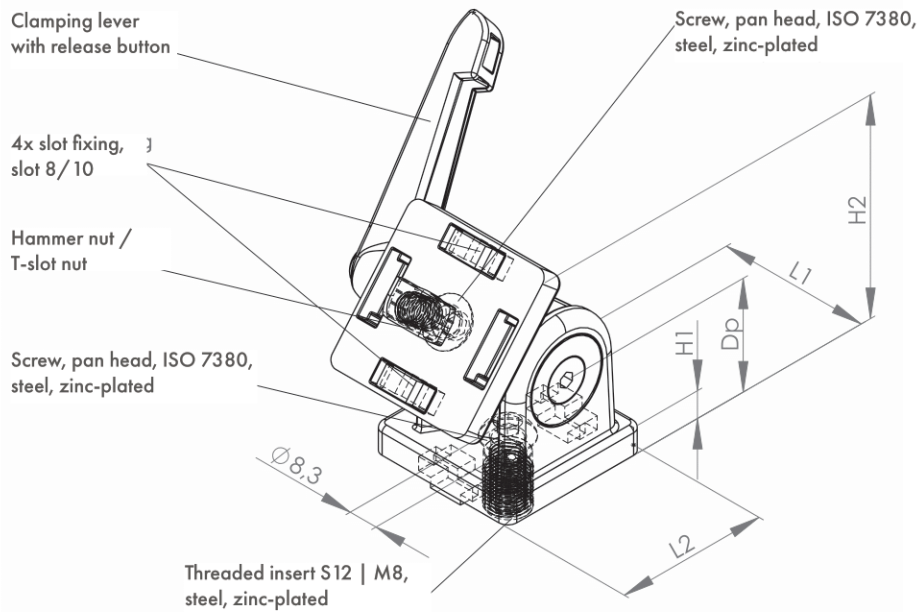

Joint: die-cast zinc, aluminium colour, powder-coated

Clamping lever: PA plastic, black

For swivelling connection of two elements.

Can be used to fix two elements at the desired angle. Joints with clamping levers can be used as mitre connectors. The joints are suitable for end-to-end and end-to-side connections



Description	L1 (mm)	L2 (mm)	Slot (mm)	H1 (mm)	H2 (mm)	Dp (mm)	Version	Clamp-able	Weight (kg)	ESD	Art. no.:
Joint 30x30 slot 8 with fastening kit	30	30	8	7	45	22.5	Fastening kit*	N*	0.15		414005
Joint 30x30 slot 8 with clamping lever and fastening kit	30	30	8	7	45	22.5	Fastening kit*	Y*	0.179		414007
Joint 40x40 slot 10 with fastening kit	40	40	10	9	60	30	Fastening kit**	N*	0.334		414009
Joint 40x40 slot 10 with clamping lever and fastening kit	40	40	10	9	60	30	Fastening kit**	Y*	0.366		414019
Joint 45x45 slot 10 with fastening kit	45	45	10	8	60	30	Fastening kit**	N*	0.334		414010
Joint 45x45 slot 10 with clamping lever and fastening kit	45	45	10	8	60	30	Fastening kit**	Y*	0.366		414020
Joint 45x90 slot 10 with fastening kit	45	90	10	9	100	50	Fastening kit***	Y*	1.84		414030
Joint 45x90 slot 10 with clamping lever and fastening kit	45	90	10	9	100	50	Fastening kit***	Y*	1.9		414040

Y* = YES
N* = NO

Fastening kit:*	Fastening kit:**	Fastening kit:***
1x screw, cylinder head, DIN 7984, M8x16, 8.8, zinc-plated	1x threaded insert S12/M8	2x threaded insert S12/M8
1x screw, cylinder head, DIN 7984, M8x20, 8.8, zinc-plated	1x hammer nut slot 10 M8	2x hammer nuts slot 10 M8
1x swivelling T-slot nut slot 8 M8 with spring sheet	1x screw, pan head, ISO 7380, M8x16, 10.9 zinc-plated	2x screws, pan head, ISO 7380, M8x16, 10.9 zinc-plated
	1x screw, pan head, ISO 7380, M8x20, 10.9 zinc-plated	2x screws, pan head, ISO 7380, M8x20, 10.9 zinc-plated
	4x slot centring pieces, slot 8/10	4x slot centring pieces, slot 8/10