

GLIDERS

Material: POM (white)

Gliders for constructing low-friction sliding guides, e.g.: sliding doors, lifting doors, slides, drawer runners and much more.

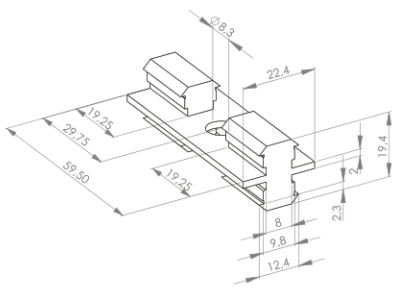

614040

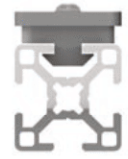
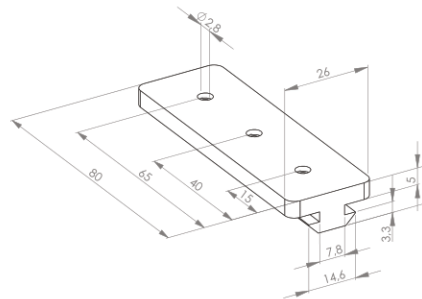

614050

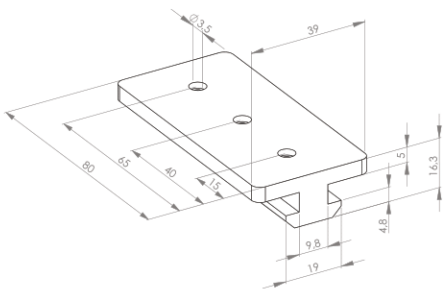

614052

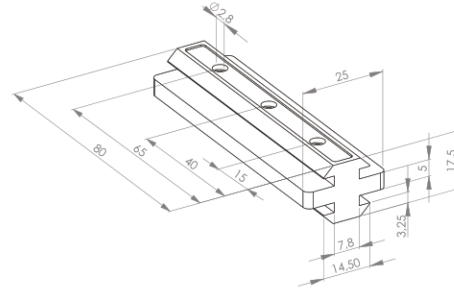

614058

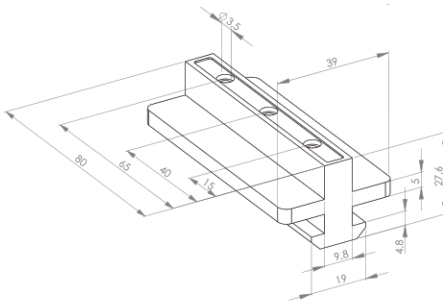

614056

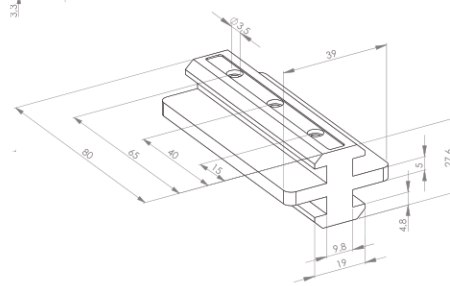

614060

Description	Slot	Weight (g)	Art. no.:
Multi-glider	8 / 10	9.1	614040
Glider, flat centre	8	19.6	614050
Glider, flat centre	10	35.4	614052
Glider, single centre	10	44.3	614056
Glider, centre	8 / 8	26.3	614058
Glider, centre	10 / 10	50.9	614060

Accessories	Weight (g)	Art. no.:
Plastic self-tapping screw, W1451, 3.5x14, 10.9	1.0	370330
Plastic self-tapping screw, W1452, 4x18, 10.9	2.0	370335