

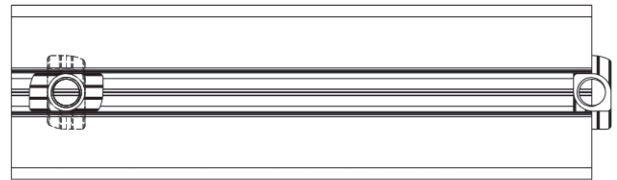

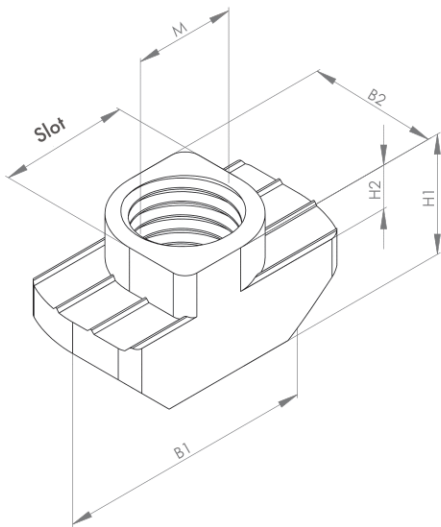



6 8 10
HAMMER NUTS 







Material: Steel, zinc-plated / stainless steel

Hammer nuts can be inserted into the side of a profile slot or inserted lengthways into the slot and then rotated by 90°.



| Description / slot 6 | M | H1 (mm) | H2 (mm) | Slot (mm) | B1 (mm) | B2 (mm) | Material | Weight (g) | ESD | Art. no.: |
|----------------------|---|---------|---------|-----------|---------|---------|--------------------|------------|---|-----------|
| Hammer nut slot 6 M4 | 4 | 4 | 0.9 | 6 | 11.6 | 5.9 | Steel, zinc-plated | 1.2 |  | 340010 |

| Description / slot 8 | M | H1 (mm) | H2 (mm) | Slot (mm) | B1 (mm) | B2 (mm) | Version | Weight (g) | ESD | Art. no.: |
|---------------------------------------|---|---------|---------|-----------|---------|---------|--------------------|------------|---|-----------|
| Hammer nut slot 8 M4 | 4 | 6 | 1.5 | 8 | 16 | 7.7 | Steel, zinc-plated | 3.9 |  | 341010 |
| Hammer nut slot 8 M5 | 5 | 6 | 1.5 | 8 | 16 | 7.7 | Steel, zinc-plated | 3.5 |  | 341020 |
| Hammer nut slot 8 M6 | 6 | 6 | 1.5 | 8 | 16 | 7.7 | Steel, zinc-plated | 3.2 |  | 341030 |
| Hammer nut slot 8 M6, stainless steel | 6 | 6 | 1.5 | 8 | 16 | 7.7 | Stainless steel | 3.5 |  | 341031 |

| Description / slot 10 | M | H1 (mm) | H2 (mm) | Slot (mm) | B1 (mm) | B2 (mm) | Version | Weight (g) | ESD | Art. no.: |
|--|---|---------|---------|-----------|---------|---------|--------------------|------------|---|-----------|
| Hammer nut slot 10 M4 | 4 | 8.8 | 3 | 10 | 19 | 9.7 | Steel, zinc-plated | 7.8 |  | 342010 |
| Hammer nut slot 10 M5 | 5 | 8.8 | 3 | 10 | 19 | 9.7 | Steel, zinc-plated | 7.5 |  | 342020 |
| Hammer nut slot 10 M6 | 6 | 8.8 | 3 | 10 | 19 | 9.7 | Steel, zinc-plated | 7.1 |  | 342030 |
| Hammer nut slot 10 M6, stainless steel | 6 | 8.8 | 3 | 10 | 19 | 9.7 | Stainless steel | 7.2 |  | 342031 |
| Hammer nut slot 10 M8 | 8 | 8.8 | 3 | 10 | 19 | 9.7 | Steel, zinc-plated | 5.6 |  | 342040 |
| Hammer nut slot 10 M8, stainless steel | 8 | 8.8 | 3 | 10 | 19 | 9.7 | Stainless steel | 5.8 |  | 342041 |