

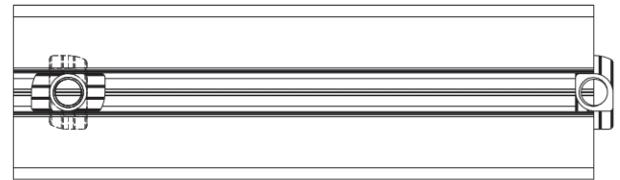

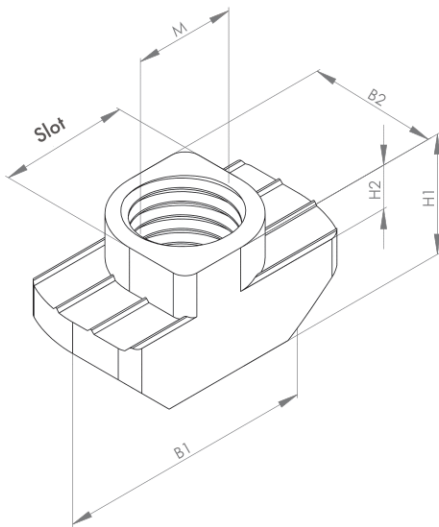



6 8 10
HAMMER NUTS 







Material: Steel, zinc-plated / stainless steel

Hammer nuts can be inserted into the side of a profile slot or inserted lengthways into the slot and then rotated by 90°.



Description / slot 6	M	H1 (mm)	H2 (mm)	Slot (mm)	B1 (mm)	B2 (mm)	Material	Weight (g)	ESD	Art. no.:
Hammer nut slot 6 M4	4	4	0.9	6	11.6	5.9	Steel, zinc-plated	1.2		340010

Description / slot 8	M	H1 (mm)	H2 (mm)	Slot (mm)	B1 (mm)	B2 (mm)	Version	Weight (g)	ESD	Art. no.:
Hammer nut slot 8 M4	4	6	1.5	8	16	7.7	Steel, zinc-plated	3.9		341010
Hammer nut slot 8 M5	5	6	1.5	8	16	7.7	Steel, zinc-plated	3.5		341020
Hammer nut slot 8 M6	6	6	1.5	8	16	7.7	Steel, zinc-plated	3.2		341030
Hammer nut slot 8 M6, stainless steel	6	6	1.5	8	16	7.7	Stainless steel	3.5		341031

Description / slot 10	M	H1 (mm)	H2 (mm)	Slot (mm)	B1 (mm)	B2 (mm)	Version	Weight (g)	ESD	Art. no.:
Hammer nut slot 10 M4	4	8.8	3	10	19	9.7	Steel, zinc-plated	7.8		342010
Hammer nut slot 10 M5	5	8.8	3	10	19	9.7	Steel, zinc-plated	7.5		342020
Hammer nut slot 10 M6	6	8.8	3	10	19	9.7	Steel, zinc-plated	7.1		342030
Hammer nut slot 10 M6, stainless steel	6	8.8	3	10	19	9.7	Stainless steel	7.2		342031
Hammer nut slot 10 M8	8	8.8	3	10	19	9.7	Steel, zinc-plated	5.6		342040
Hammer nut slot 10 M8, stainless steel	8	8.8	3	10	19	9.7	Stainless steel	5.8		342041